

# Techni

## Stereo Cassette Deck

### RS-AZ7/RS-AZ6

#### Operating Instructions



The photograph shows the RS-AZ7 model.

**Note:**

The "EB" indication shown on the packing case indicates United Kingdom.

Before connecting, operating or adjusting this product, please read these instructions completely.

EB

RQT3434-B

# Dear Customer

Thank you for purchasing this product.  
For optimum performance and safety, please read these instructions carefully.

These operating instructions are applicable to the RS-AZ6 and RS-AZ7 models.  
These instructions, however, fundamentally explain the operation of the RS-AZ7 model.

## Table of contents

### Before use

Caution for AC mains lead (For United Kingdom).....	3
Suggestions for safety .....	4
Front panel controls .....	5
Connections .....	6

### Playback

Playback <b>Basic play</b> .....	7
About the automatic-tape-select function.....	7
About the AZ head .....	8
About the Play Direct function <b>RS-AZ7 only</b> .....	8
About the Dolby noise-reduction system .....	8
About the Dolby HX-Pro headroom extension system .....	8
Linear counter .....	9
To reset the linear counter .....	9
To find the beginning of a program (TPS function).....	9
To fast-forward or rewind the tape .....	10
Memory stop function .....	10
Listening through headphones .....	11

### Recording

Recording.....	12
About the ATC function .....	14
To monitor the sound during recording .....	15
To record high-quality FM broadcasts (MPX filter).....	15
To make a timer playback/recording <b>RS-AZ7 only</b> .....	16
Timer playback.....	16
Timer recording .....	16
To make a silent interval .....	17
To make a 4-second silent interval .....	17
To make a silent interval more than 4 seconds.....	17

### Reference

Maintenance.....	17
Concerning cassette tapes.....	18
Technical specifications .....	19
Troubleshooting guide .....	Back cover

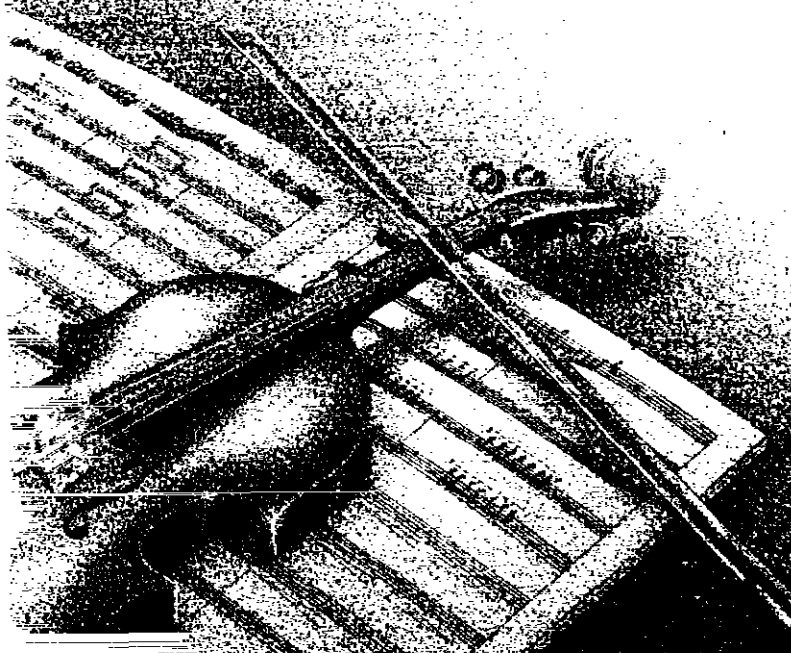

# Caution for AC mains lead

## (For United Kingdom)

("EB" area code model only)

For your safety, please read the following text carefully.

This appliance is supplied with a moulded three pin mains plug for your safety and convenience.

A 5-ampere fuse is fitted in this plug.

Should the fuse need to be replaced please ensure that the replacement fuse has a rating of 5-ampere and that it is approved by ASTA or BSI to BS1362.

Check for the ASTA mark  or the BSI mark  on the body of the fuse.

If the plug contains a removable fuse cover you must ensure that it is refitted when the fuse is replaced.

If you lose the fuse cover the plug must not be used until a replacement cover is obtained.

A replacement fuse cover can be purchased from your local dealer.

### CAUTION!

IF THE FITTED MOULDED PLUG IS UNSUITABLE FOR THE SOCKET OUTLET IN YOUR HOME THEN THE FUSE SHOULD BE REMOVED AND THE PLUG CUT OFF AND DISPOSED OF SAFELY.

THERE IS A DANGER OF SEVERE ELECTRICAL SHOCK IF THE CUT OFF PLUG IS INSERTED INTO ANY 13-AMPERE SOCKET.

If a new plug is to be fitted please observe the wiring code as shown below.

If in any doubt please consult a qualified electrician.

### IMPORTANT

The wires in this mains lead are coloured in accordance with the following code:

Blue: Neutral

Brown: Live

As the colours of the wires in the mains lead of this appliance may not correspond with the coloured markings identifying the terminals in your plug, proceed as follows:

The wire which is coloured BLUE must be connected to the terminal in the plug which is marked with the letter N or coloured BLACK.

The wire which is coloured BROWN must be connected to the terminal in the plug which is marked with the letter L or coloured RED.

Under no circumstances should either of these wires be connected to the earth terminal of the three pin plug, marked with the letter E or the Earth Symbol .

### Before use

Remove the connector cover as follows.

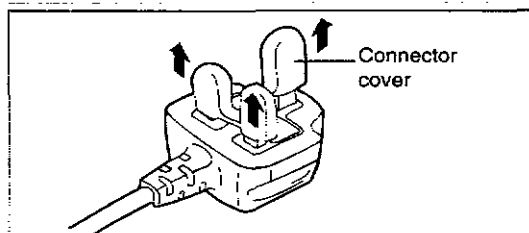

### How to replace the fuse

1. Remove the fuse cover with a screwdriver.

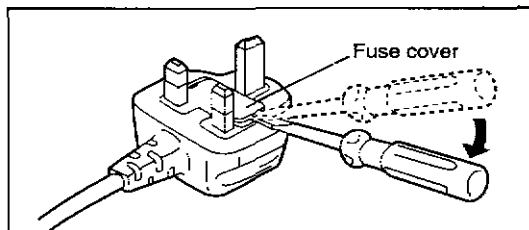

2. Replace the fuse and attach the fuse cover.

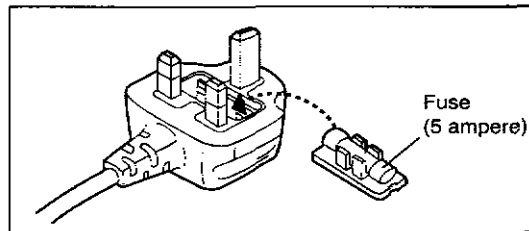

# Suggestions for safety

## Placement

Avoid placing the unit in areas of:

- direct sunlight
- high temperature
- high humidity
- excessive vibration
- uneven surfaces. (Place the unit on a flat level surface).

Such conditions might damage the cabinet and/or other component parts and thereby shorten the unit's service life.

## Ventilation

Place the unit in a well ventilated position at least 10 cm away from wall surfaces etc.

## Stacking

Never place heavy items on top of the unit or the power cord.

## Voltage

- It is very dangerous to use an AC power source of high voltage such as for an air conditioner.  
A fire might be caused by such a connection.
- A DC power source can not be used.  
Be sure to check the power source carefully, especially on a ship or other place where DC is used.

## Power cord protection

- Avoid cuts, scratches or poor connection of the AC mains cord, as this may result in fire or electric shock hazard.  
Excessive bending, pulling or slicing of the cord should also be avoided.
- Do not pull on the cord when you are disconnecting the power, as this could cause an electric shock. Grasp the plug firmly when you disconnect the power supply.
- Never touch the plug with wet hands or a serious electric shock could result.

## Foreign materials

- (If there are ventilation holes)  
Ensure that no foreign objects, such as needles, coins, screwdrivers etc, accidentally fall into the unit or through the ventilation holes.  
Otherwise, a serious electric shock or malfunction could occur.
- Be extremely careful about spilling water or liquid on/into the unit, as a fire or electric shock could occur.  
(Disconnect the power plug and contact your dealer immediately if this occurs.)
- Avoid spraying insecticides onto the unit as they contain flammable gases which can be ignited.
- Insecticides, alcohol, paint thinner and similar chemicals should never be used to clean the unit as they can cause flaking or cloudiness to the cabinet finish.

## Maintenance (See page 17.)

Clean the cabinet, panel and controls with a soft cloth lightly moistened with mild detergent solution.

Do not use any type of abrasive pad, scouring powder or solvent such as alcohol or benzene.

## Service

- Never attempt to repair, disassemble or reconstruct the unit if there seems to be a problem.  
A serious electric shock could result if you ignore this precautionary measure.
- If a problem occurs during operation (the sound is interrupted, indicators fail to illuminate, smoke is detected, etc) contact your dealer or Authorised Service Center immediately.
- Disconnect the power supply if the unit will not be used for a long time. Otherwise the operation life could be shortened.

### CAUTION!

DO NOT INSTALL OR PLACE THIS UNIT IN A BOOKCASE, BUILT IN CABINET OR IN ANOTHER CONFINED SPACE IN ORDER TO KEEP WELL VENTILATED CONDITION. ENSURE THAT CURTAINS AND ANY OTHER MATERIALS DO NOT OBSTRUCT THE VENTILATION CONDITION TO PREVENT RISK OF ELECTRIC SHOCK OR FIRE HAZARD DUE TO OVERHEATING.

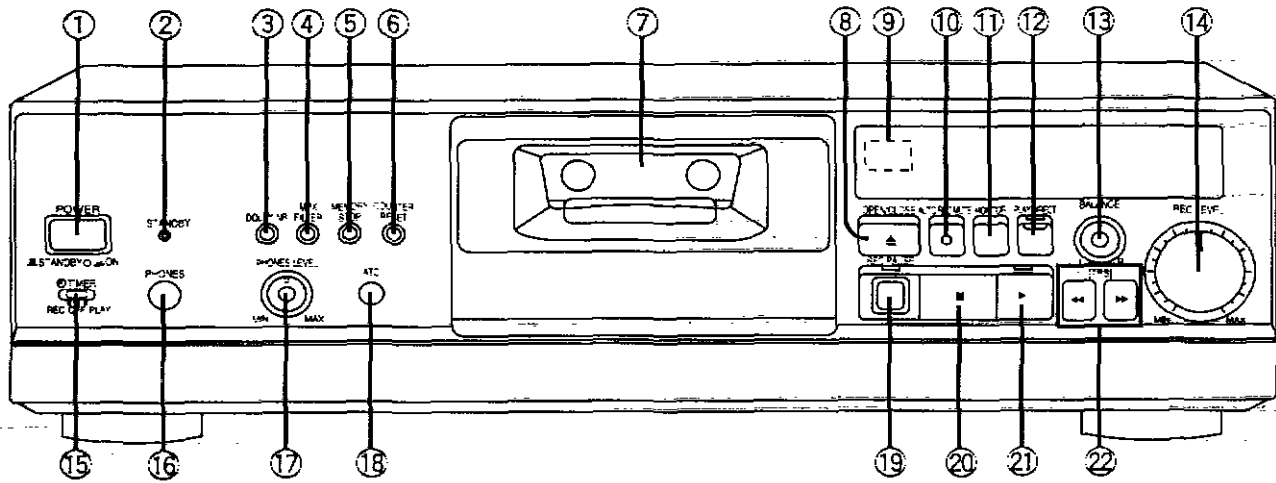

No.	Name	Ref. page
①	Power "  STANDBY  ON" switch (POWER,  STANDBY  ON)	7
Press to switch the unit from on to standby mode or vice versa. In standby mode, the unit is still consuming a small amount of power.		
②	"STANDBY" indicator (STANDBY)	-
With the POWER button in the ON position (  ) the unit can be switched between the STANDBY and ON condition using the remote control. In the STANDBY condition the indicator will light.		
③	Dolby noise-reduction button (DOLBY NR)	7
④	Multiplex filter button (MPX FILTER)	15
⑤	Memory stop button (MEMORY STOP)	10
⑥	Counter reset button (COUNTER RESET)	9
⑦	Cassette holder	-
⑧	Cassette holder open/close button (  OPEN/CLOSE)	7
⑨	Remote control signal sensor	-
This cassette deck can be operated by using the remote control provided with a Technics amplifier or receiver. [See the operating Instructions of the amplifier or the receiver for details.]		
⑩	Automatic-record-muting button (  AUTO REC MUTE)	17
⑪	Monitor button (MONITOR)	15

No.	Name	Ref. page
⑫	Play direct button (PLAY DIRECT) <b>RS-AZ7 only</b>	8
⑬	Recording-balance control (BALANCE)	12
⑭	Recording-level control (REC LEVEL)	12
⑮	Timer control (  TIMER) <b>RS-AZ7 only</b>	16
⑯	Headphones jack (PHONES)	11
⑰	Headphones volume control (PHONES LEVEL)	11
⑱	Auto tape calibration button (ATC)	12,13,14
⑲	Recording pause button (REC PAUSE)	12
⑳	Stop button (  )	7
㉑	Playback/record button (  )	7
㉒	Rewind/fast-forward search buttons (  /  [TPS])	9,10

# Connections

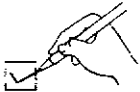

Please check and identify the supplied accessories

AC power supply cord (RJA0049-K) .....1 pc.

Stereo connection cables (RJL4P004B08) ..... 2 pcs.

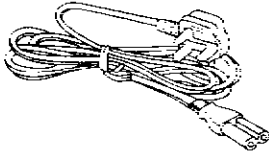

Before making connections, make sure that the power to this unit and all other system components is turned off.

**Note**

- Avoid letting the cables touch each other as much as possible, otherwise noise will be generated.
- Although the figure below shows the AC power supply cord being connected to a household AC outlet, if the amplifier (or receiver) is equipped with an AC outlet, connect the cord to that outlet.

**Placement hints**

If this unit is placed near a receiver or a tuner, a "hum" noise may be heard during tape playback, recording, or AM reception of the receiver or the tuner.

If this occurs, leave as much space as possible between the units, or place them where there is the least amount of "hum".

**BE SURE TO READ THE CAUTION FOR AC POWER SUPPLY CORD ON PAGE 3 BEFORE THE FOLLOWING CONNECTIONS.**

**Note**

Do not place this unit on top of an amplifier. Heat radiated from the top of the amplifier may cause damage to the tape.

**Insertion of Connector**

Even when the connector is perfectly inserted, depending on the type of inlet used, the front part of the connector may jut out as shown in the drawing.

However there is no problem using the unit

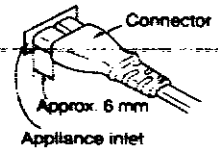

**Stereo connection cable**

White (L)  
Red (R)

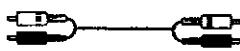

Amplifier or receiver

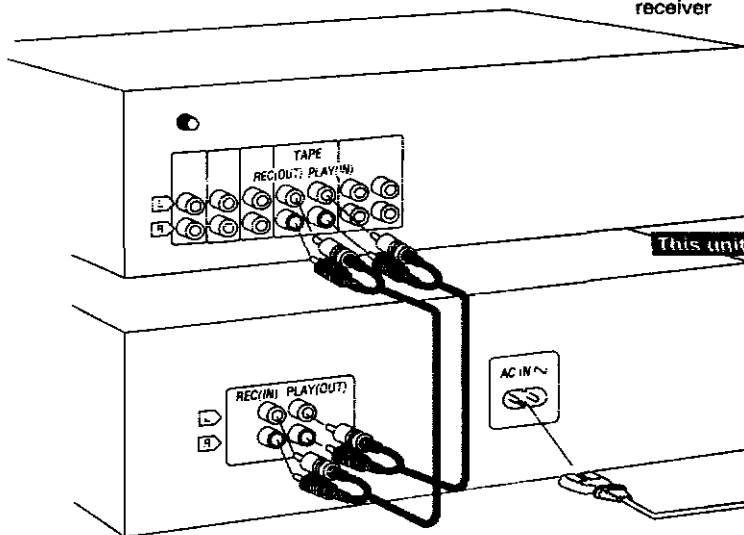

Connect this cord after all other cables and cords are connected.

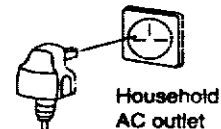

# Basic play

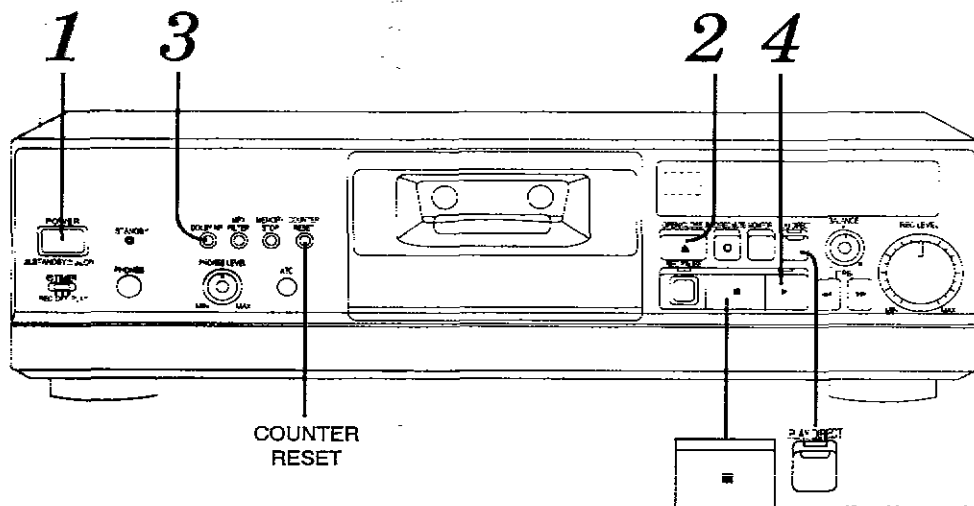

**1** **POWER**  
**Press POWER.**  
 (The unit will switch on.)

**2** **OPEN/CLOSE**  
**Press OPEN/CLOSE, and then insert the cassette tape.**  
 Press again to close the cassette holder.

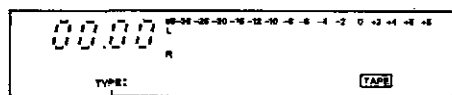
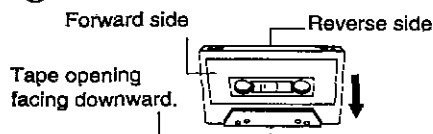

The tape type will be displayed.

**3** **DOLBY NR**  
**Press DOLBY NR to select the appropriate noise-reduction system.**

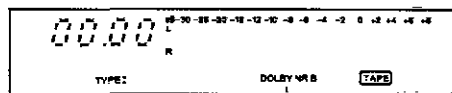

Each time the button is pressed, the indicator will change in the order:

DOLBY NR B → DOLBY NR C → off

Select whichever you normally use for recording.

**4**  
**Press ►.**  
 (Playback will begin.)

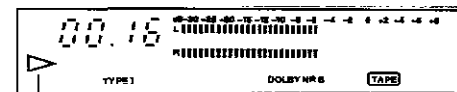

Illuminates

### To stop playback

**Press ■.**

### For your reference:

When the cassette holder is open, pressing ►, ◀◀ or ▶▶ will close the holder and begin the playback, fast-forwarding or rewinding the tape.

Type of tape which can be played correctly:

The unit automatically identifies the type of tape.

Normal position/ TYPE I	○
High position/ TYPE II	○
Metal position/ TYPE IV	○

### About the automatic-tape-select function

This unit is equipped with the automatic-tape-select feature; it automatically detects the type of tape being used, and then makes the suitable adjustments of the bias and equalization accordingly. The type of tape being used will be automatically detected and the indicator will illuminate.

**TYPE I** : Normal position

**TYPE II** : High position

**TYPE IV** : Metal position

## About the AZ head

This unit comes with a newly developed AZ head. AZ stands for amorphous Z. The recording head is the same as before, but the playback head has been built with new technology [Magnet Resistive (MR) device, thin film head, amorphous material]. Compared to older heads, the AZ head has the following advantages.

- Noise level is low because the MR device efficiently converts the magnetic signals into electric signals, which keeps impedance down.

### What is the MR device ?

It's a device that changes resistance by varying the magnitude of a magnetic field.

- Playback is possible with a wider range of sources thanks to the MR device and thin film head.
- Flat frequency characteristics are obtained because the contour effect doesn't occur.

### What is the contour effect ?

Depending on how the head core is configured, frequency characteristics tend to wander in the low range. The AZ head has a thin-film construction which minimizes the area contacting the tape, thus the contour effect doesn't occur.

## About the Play Direct function

### RS-AZ7 only

This function lets you enjoy the clear sounds reproduced with the AZ head. When Play Direct is ON, the AZ head preamp outputs directly from the LINE OUT terminal instead of passing signals first through the bias trap and the noise reduction circuit.

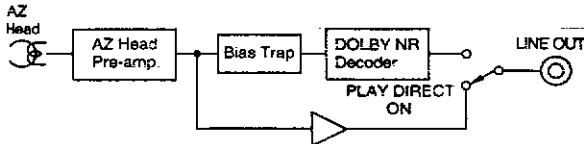

### How to use

[While playback is stopped]



#### 1. Press PLAY DIRECT.

The indicator immediately above the button will flash for about 1.5 seconds and then will light up solidly.

#### 2. Press ►.

Playback will start.

### Note

If you press PLAY DIRECT while playing back a source, the sound will be muted instantly, but it will return in about 1.5 seconds.

### To cancel Play Direct

[While playback is stopped]

Press PLAY DIRECT.

### Note

- Do not use the Play Direct function when playing back tapes recorded in Dolby NR.
- You cannot use the Play Direct function while recording.

## About the Dolby noise-reduction system

The Dolby noise-reduction system is designed to effectively reduce the annoying high-frequency "hissing" noise typical of cassette tapes. During recording, the system functions to increase the high-frequency sound level, the sound, and then, during playback, that same portion is weakened to bring it back to the previous level.

This unit includes two types of Dolby noise-reduction systems, the Dolby B NR-type and C NR-type.

### Dolby B-type noise-reduction

Noise is reduced to about one-third.

Use this system when playing back tapes recorded by the Dolby-B noise-reduction system, such as prerecorded music tapes, etc.

### Dolby C-type noise-reduction

Noise is reduced to about one-tenth.

Use this system for the recording and playback of sound sources that have a wide dynamic range and good tone quality, such as FM broadcasts of live performances, etc., and for playing back such tapes.

## About the Dolby HX-Pro headroom extension system

By functioning to improve the maximum output level of the tape's high-frequency range, this system permits recordings without a reduction in the level of the sound source's high-frequency range. In addition, by using the system in parallel with this unit's noise-reduction system, recording and playback with a greatly extended dynamic range is possible.

Dolby noise reduction and HX Pro headroom extension manufactured under license from Dolby Laboratories Licensing Corporation. HX Pro originated by Bang & Olufsen. "DOLBY", the double-D symbol  and "HX PRO" are trademarks of Dolby Laboratories Licensing Corporation.



The linear counter indicates the amount of tape travel as the approximate amount of elapsed time.

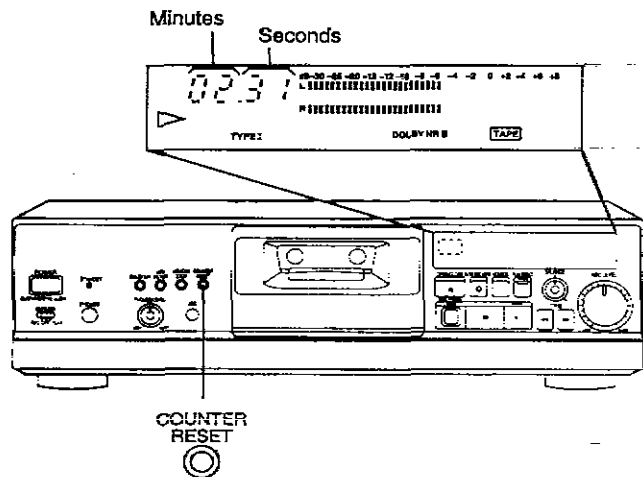

**To find the beginning of a program (TPS function)**

(TPS: Tape Program Sensor)

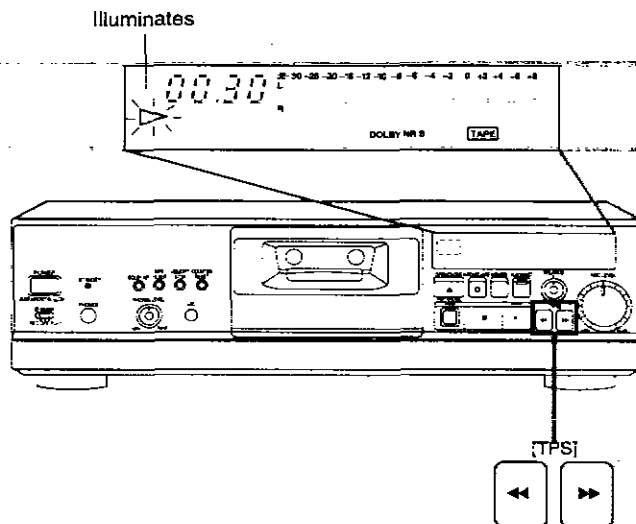

**To reset the linear counter**

COUNTER RESET



**Press COUNTER RESET.**  
The linear counter indication will return to "00.00".

**Note**

The linear counter is not a digital clock. The difference between the actual recording and playback time and the counter display may be anything up to several minutes.

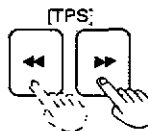

[While tape is being played back]

**Press ◀◀ or ▶▶.**  
(The tape will be re-wound or fast-forwarded to the beginning of the track, and then playback will automatically begin.)

Tape returns to the beginning of the track currently being played, and playback begins.	Playback begins from the beginning of the next track.
◀◀	▶▶

- During operation of the TPS function, "▷" indicator will flash quickly.
- To find the beginning of a track which is several tracks before or after the track currently being played, repeat the procedure until the desired track is found.

**Note**

Because the TPS function utilizes the blank spaces between tracks, it may not be able to function properly under the following conditions:

- When there is less than 4 seconds of silent interval between tracks
- When there are no completely silent intervals (such as when the tape has been recorded using a microphone)
- When there are especially low-level parts or silent parts inside a track (such as sometimes occurs in classical music)
- If the ◀◀ or ▶▶ button is pressed during playback when less than 10 seconds has elapsed from the beginning of the track or there is less than 10 seconds remaining to the beginning of the next track
- If the tracks have been recorded with a fade-in (a gradual increase in the recording level) or a fade-out (a gradual decrease in the recording level)

## To fast-forward or rewind the tape

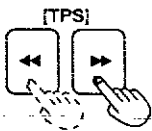
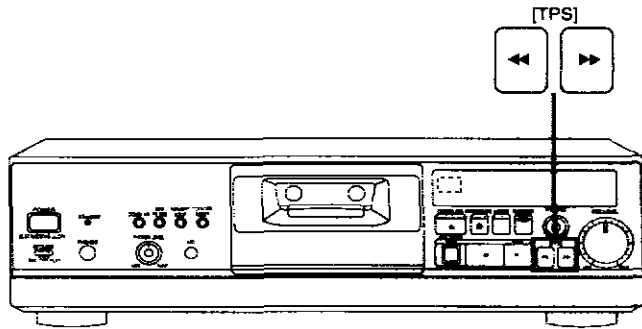

[In stop mode]  
Press ◀◀ or ▶▶.

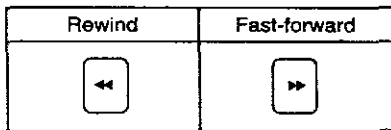

## Memory stop function

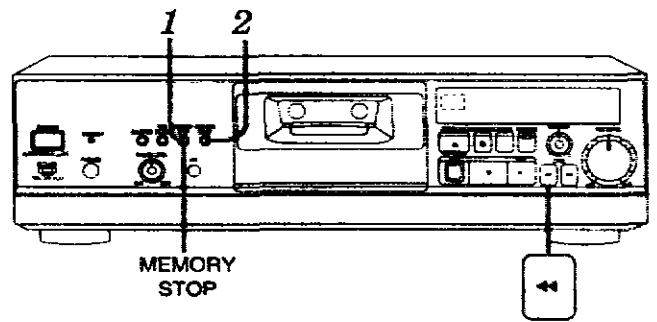

**1**



[While the tape deck is paused, playing back or recording a tape]  
**Press MEMORY STOP.**

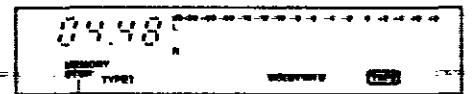

Illuminates

### High-speed tape transport

When fast-forwarding from near the beginning of the tape or when rewinding from near the end of the tape, the tape travel speed will be faster than that during normal fast-forwarding or rewind.

- During high-speed tape transport, the **H** indication will light up.
- To return to the normal speed during high-speed tape transport

Press the ◀◀ or ▶▶ button corresponding to the current direction of tape travel.

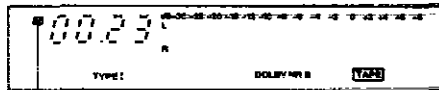

**H** indication

**2**



[While the tape deck is paused, playing back or recording a tape]  
**Press COUNTER RESET at the point where you wish to start playback or recording.**  
This point will be memorized as the rewind position.

The counter will be reset to "00:00".

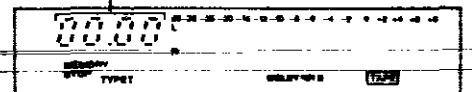

### For your reference

The tape does not always travel at high speed when you start fast-forwarding or rewinding from somewhere in the middle.

### To rewind to the memorized point:

[While the tape deck is paused after playback or recording]

**Press ◀◀ to rewind the tape.**

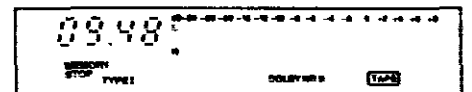

The tape will stop rewinding when the counter reaches "00:00".

### To clear a memory stop point:



**Press MEMORY STOP.**

### Note

The position where the counter was reset and the actual stopping position may be slightly different (within an error of 4 seconds).

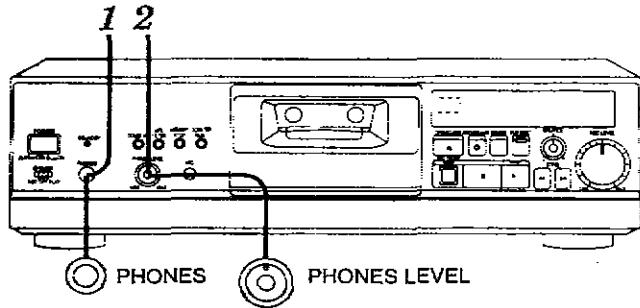

**Preparation:**

Set PHONES LEVEL to "MIN".

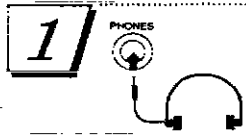

**Connect the headphones.**

Headphones (not included)  
Plug type: 6.3 mm phone plug stereo type

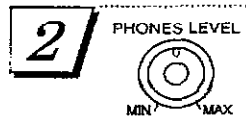

**Use the PHONES LEVEL control to adjust the volume.**

To increase the volume:  
Turn to the right

To decrease the volume:  
Turn to the left

**Note**

Avoid listening for prolonged periods of time to prevent hearing damage.

# Recording

This unit is equipped with an ATC function (refer to page 14) which automatically sets the optimum recording conditions to match the characteristics of the tape being used. It is recommended that you use this function when recording.

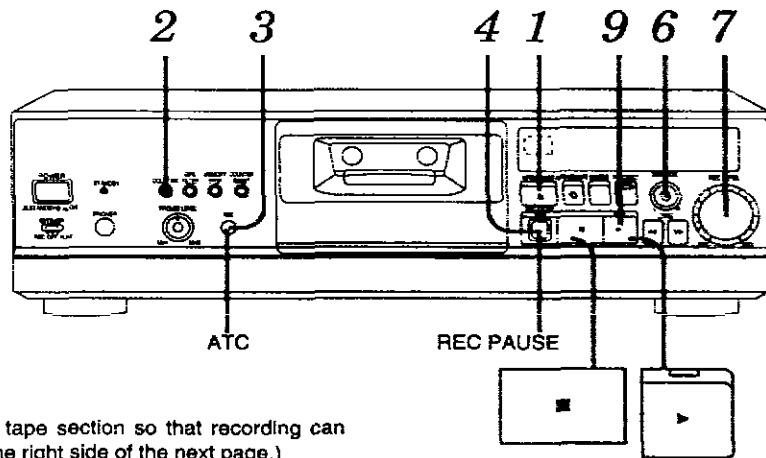

## Preparation:

Wind the tape past the leader tape section so that recording can begin straight away. (Refer to the right side of the next page.)

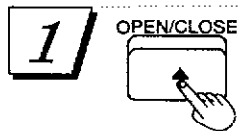

**Press OPEN/CLOSE, and then insert the cassette tape.**



**Press DOLBY NR to select the desired noise-reduction system.** (Refer to page 8.)

If the tape will not be recorded using Dolby NR, press DOLBY NR again so that the Dolby NR B or C indicator will go off.

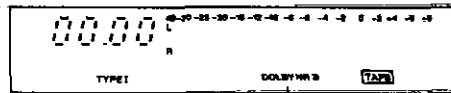

Each time the button is pressed, the indicator will change in the order:  
DOLBY NR B → DOLBY NR C → off



**Press ATC.**

Setting of the ATC (refer to page 14) will commence, and will be completed after approximately 30 seconds.

When the settings are complete, the tape will be returned to the position from which the ATC function began, and then the unit will enter the stop mode.

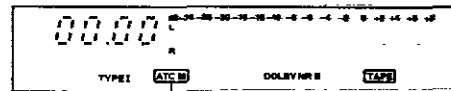

Indicates that the ATC function is ON.  
(Changes from flashing to solidly lit.)

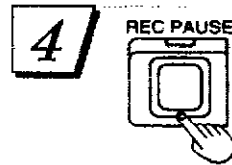

**Press REC PAUSE.**

(The unit will be in the recording standby mode.)

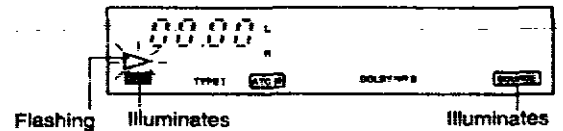

**Play the source in order to adjust the recording sound.**



**Set the BALANCE control to the center position.**

If necessary, adjust the BALANCE control to adjust the balance.



**Use the REC LEVEL control to adjust the recording level.**

(Refer to the right side of the next page.)



**Stop play of the source.**

## Note

When you turn ON the ATC function, a test signal is immediately recorded on the tape. If you start recording, the test signal is automatically erased. But if you don't it remains on the tape. Always remember to record something when you use the ATC function.

9

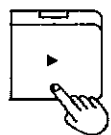

Press ► to begin recording, and play the source to be recorded.



Type of tape which can be recorded correctly:  
The unit automatically identifies the type of tape.

Normal position/ TYPE I	<input type="radio"/>
High position/ TYPE II	<input type="radio"/>
Metal position/ TYPE IV	<input type="radio"/>

**To temporarily stop recording**



Press **REC PAUSE**.  
(The unit will be in the recording standby mode.)  
Press ► to resume recording.

**To stop recording**

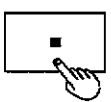

Press ■.

The unit uses the memory stop function to memorize the point where you started recording from. (See page 10.)

**To cancel the ATC settings**

[While ATC settings are in progress]

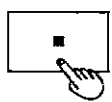

Press ■.

[After ATC settings have been completed]

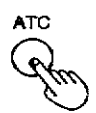

Press **ATC**.

if **ATC M** begins to flash quickly while the ATC settings are in progress, it indicates that the settings cannot be made for one of the following reasons.

- The tape has reached the leader tape.
- The tape is severely damaged.
- The cassette deck's heads are severely dirty.
- The tape is a non-standard type, such as a metal tape which has no tape identification holes in the cassette.

**Note**

- When you use the ATC function with an already recorded tape, the section of the tape where the test signal is normally recorded is erased when you turn ON the function. Always start recording at least 2 seconds before recorded tracks, especially if wanting to record with ATC from the middle of the tape.
- The ATC function does not work at the end of the tape.

**To wind the leader tape**

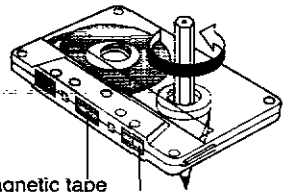

Magnetic tape (recording can be made)  
Leader tape (no recordings can be made)

**About the selection of the Dolby NR type**

The Dolby NR effect can be obtained by using the same type of Dolby NR during both recording and playback. Refer to the following table when selecting the type (either B or C).

<b>Type B</b>	Use this type when the deck on which the tape will be played back is equipped with only type B Dolby NR.
<b>Type C</b>	Use this type when the deck on which the tape will be played back is equipped with only type C Dolby NR. (for example, when this unit is also going to be used to play back the tape.)

(Refer to "About the Dolby noise-reduction system" on page 8.)

**About the left/right balance adjustment**

Depending on the source you want to record from, you may have to adjust left/right balance. In such case, watch the level meter while adjusting balance.

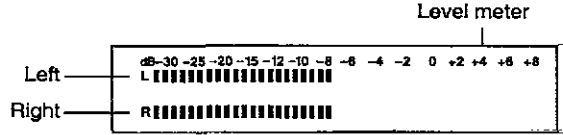

**About the recording level adjustment**

If the recording level is too high, there will be distortion in the recorded sounds, and if it is too low, the hiss noise inherent to recording tapes will become noticeable.

In order to make high-quality recordings, use the REC LEVEL control to adjust so that highest values of the input level indicated by the level meter do not exceed the standard recording level (the number indicated in parentheses) for the tape being used.

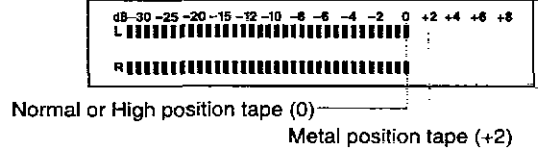

**For your reference**





When recording without using the ATC function, step 3 is unnecessary.

Your attention is drawn to the fact that recording pre-recorded tapes or discs or other published or broadcast material may infringe copyright laws.

# About the ATC function

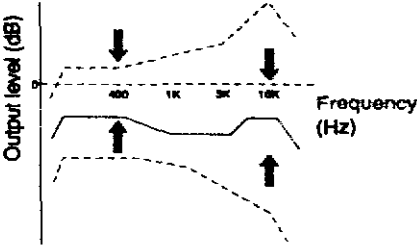
The ATC (auto tape calibration) function records a test signal in order to automatically set the bias, equalizer and recording/playback level to the optimum recording conditions in accordance with the characteristics of the tape being used.

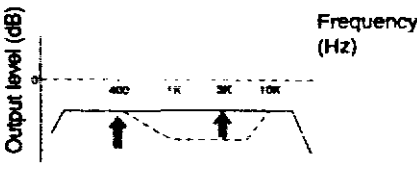
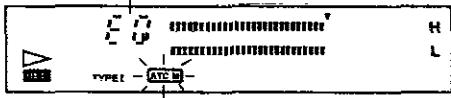
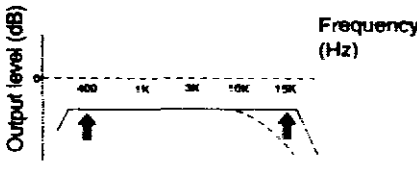
The table below shows the conditions of the display and the operation of the unit while the ATC settings are being made.

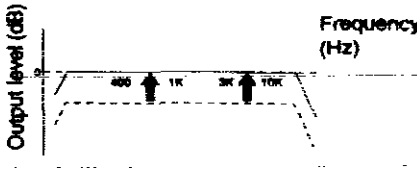
	Display	Unit operation
① Bias adjustment	<p>"BIAS" illuminates.</p>  <p>Flashing</p>	<p>The bias is adjusted so that the output level is the same at 400 Hz and at 10 kHz.</p> 
② Equalizer adjustment (middle frequency range)	<p>"EQ" illuminates.</p>  <p>Flashing</p>	 <p>The bias is adjusted so that the output level is the same at 400 Hz and at 3 kHz.</p>
③ Adjusting the high frequency range	<p>"EQ" illuminates.</p>  <p>Flashing</p>	 <p>The high frequency range may be effected by equalizer setting (middle frequency range). Set output at 400Hz and 15 kHz to the same level.</p>
④ Level adjustment	<p>"LEVEL" illuminates.</p>  <p>Flashing</p>	 <p>The tape sensitivity is compensated so that the recording input level and the playback output level are the same.</p>



It is possible to separately monitor the sound which is being recorded from a recording source and the sound being recorded to a tape. This function works when the unit is connected to an amplifier which is equipped with a tape monitor.

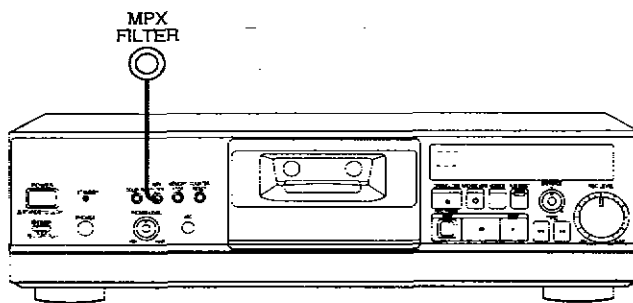
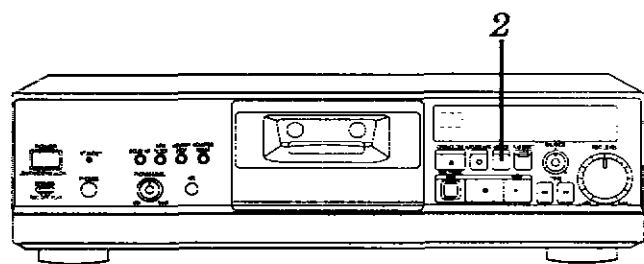

**Preparation:**

Set the Input selector and the tape monitor to the same recording source.

**1**

Set the tape monitor on the amplifier to "TAPE".

**2**

MONITOR



Press MONITOR to monitor the recording source sound or tape sound.

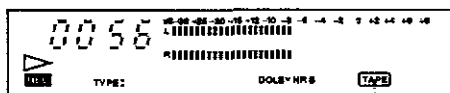

Each time the button is pressed, the monitoring sound switches between "Tape" and "SOURCE".

MPX FILTER



[Before recording an FM stereo broadcast]

Press MPX FILTER.

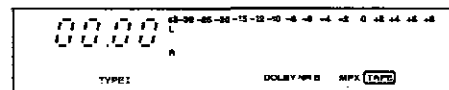

Illuminates

**Note**

- When recording a source other than an FM broadcast, press MPX FILTER once to cancel the MPX filter function.
- The MPX filter function has no effect on the playback quality of recordings.

**What is the MPX filter function?**

A pilot signal is included in FM stereo broadcasts for the purpose of separating the left and right stereo channels. When recording FM broadcasts using Dolby noise Reduction, the noise reduction processing is carried out for this pilot signal also, causing a deterioration in sound quality and a decrease in the noise reduction effect. The MPX filter eliminates the constant 19 kHz signal which is used as the pilot signal.

# To make a timer playback/recording **RS-AZ7 only**

You can playback tapes or record radio broadcasts at a specific time if you have a tuner with a built-in timer or an audio timer (not included). (For connections, see page 6.)

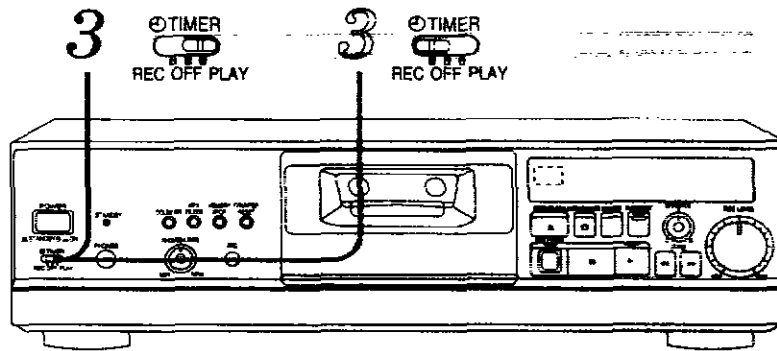

## Timer playback

You have to set the amplifier (input source, volume, etc.) as when wanting to listen to tapes, in advance.

- 1** **Set the tape deck for playback.**  
Insert a tape and set the type of Dolby NR. (See steps 1 through 3 on page 7.)
- 2** **Set the timer to the time you want playback to start.**  
(See the instruction manual that came with tuner or audio timer.)  
When you complete the setting, the unit and peripheral components will turn OFF.
- 3** **Set  $\odot$  TIMER control to "PLAY".**  
The tape will be played back automatically at the set timer.  

## Timer recording

Before doing anything, tune in the radio broadcast and make sure reception is all right. Also, make sure the amplifier and tuner are connected to this unit.

(For details, see the operating instructions that came with your equipment.)

- 1** **Set the tape deck for recording.**
  - ① Insert a tape.
  - ② Set the type of Dolby NR.
  - ③ Turn ATC ON. (You can record just the same when OFF.)
  - ④ Set recording level. (See steps 1 through 7 on page 12.)
- 2** **Set the timer to the time you want to start recording.**  
(See the operating instructions that came with tuner or audio timer.)  
When you complete the setting, the unit and peripheral components will turn OFF.
- 3** **Set  $\odot$  TIMER control to "REC".**  
Recording will start automatically at the set time.  

### Note

#### When timer playback/recording is over

Return the  $\odot$  TIMER control to "OFF".



## To make a silent interval

A silent interval of 4 seconds or more can be provided between tracks. This function is useful for playing back on decks which can skip to the beginning of tracks, and for cutting unwanted sound from commercials.

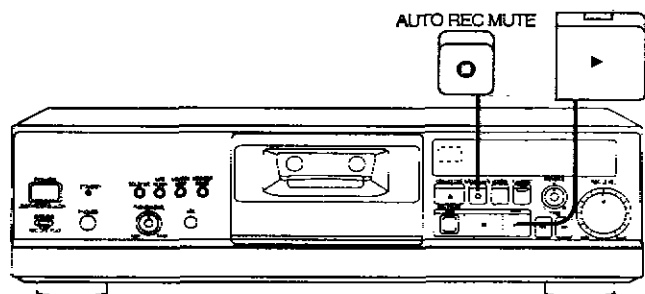

### To make a 4-second silent interval

AUTO REC MUTE



Press **AUTO REC MUTE** momentarily while a recording is being made.

A 4-second silent interval will be recorded, and the unit will automatically be set to the recording standby mode.

### To make a silent interval more than 4 seconds

AUTO REC MUTE



Press and hold **AUTO REC MUTE** for the necessary number of seconds while a recording is being made.

The unit will change to the recording stand-by mode when the button is released.

### To resume recording

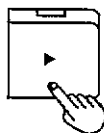

Press **▶**.

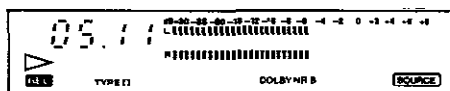

## Maintenance

### Head care

To assure sound quality for recording and playback, be sure to clean the heads after approximately every 10 hours of use.

- 1) Press OPEN/CLOSE to open the cassette holder.
- 2) Turn OFF the unit.
- 3) Clean the heads, pinch roller and the capstan shaft with a cotton swab (or with a soft, lint-free cloth) slightly moistened with isopropyl alcohol.

Do not use any solution other than alcohol for head cleaning.

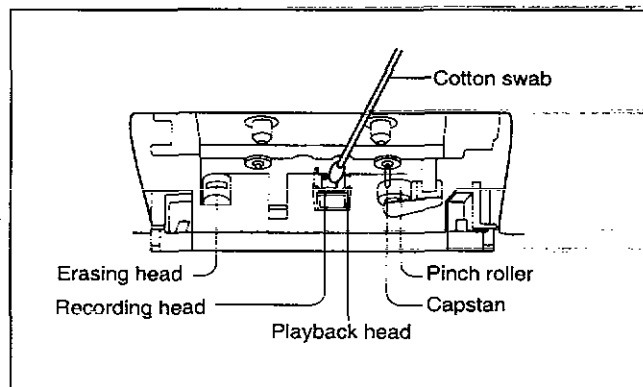

#### Note

- NEVER use a demagnetizer. You will seriously damage the head if you use a demagnetizer. Though this was possible with older model heads, the AZ head built into this unit works on a completely different principle. A head demagnetizer will apply a strong magnetic force to the head which will cause a drop in performance.
- Do not touch the heads.
- Do not insert hands or other objects deeply inside equipment.

### Maintenance of external surfaces

To clean this unit, use a soft, dry cloth.

If the surfaces are extremely dirty, use a soft cloth, dipped into a soap-and-water solution or a weak detergent solution. Wring the cloth well before wiping the unit.

Wipe once again with a soft, dry cloth.

Never use alcohol, paint thinner, benzine, nor a chemically treated cloth to clean this unit.

Such chemicals may damage the finish of your unit.

# Concerning cassette tapes

## Selection of cassette tapes

### Cassette tapes exceeding 100 minutes

These tapes are handy for their long playback and recording time but be careful about repeatedly stopping and starting; rewinding and fast forwarding these tapes in short intervals as they are thin, tend to stretch and may become entangled in the machine.

### Endless tapes

Failure to operate these tapes correctly may cause the tape to wind around the revolving parts.

## Tape slack

Tape slack may cause the tape to break.

Use a pencil or similar object to take up the slack.

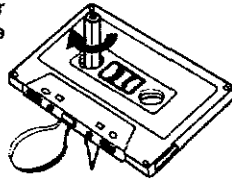

## Erasure prevention

Remove the tab(s).

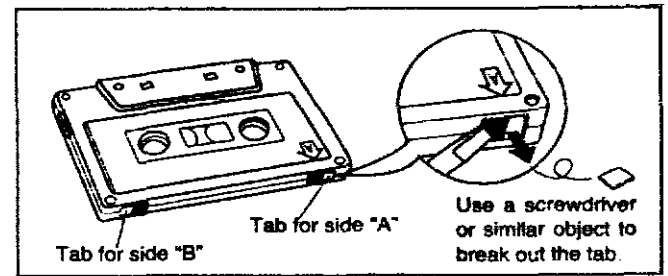

## To re-record on a protected cassette

Cover the slot with adhesive tape.

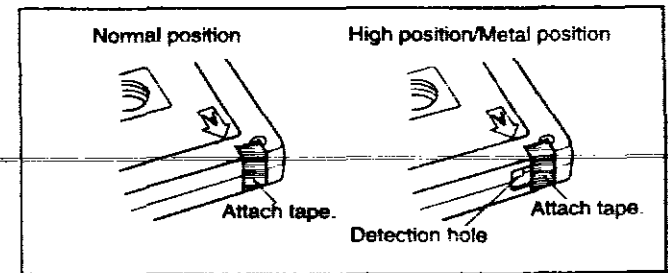

## Tape storage

Tapes can be damaged if stored in places such as those described below.

- Where the temperature is high (35°C or higher) or where the humidity is high (80% or higher)
- Where there is a strong magnetic field (near a speaker, on top of a TV, etc.). Recording may become erased.
- In direct sunlight

## ■ CASSETTE DECK SECTION

Deck system	Stereo cassette deck
Track system	4-track, 2-channel
Recording system	AC bias
Bias frequency	210 kHz
Erasing system	AC erase
Heads	Recording head (Permalloy)×1 Playback head (Thin-Film type)×1 Erasing head (Double-gap ferrite)×1
Motors	Capstan drive (DC servo motor)×1 Reel table drive (DC motor)×1
Tape speed	4.8 cm/s
Wow and flutter	0.07% (WRMS) ±0.2% (DIN)
Fast forward and rewind times	Approx. 35 seconds with C-60 cassette tape
Frequency response (Dolby NR off)	
TYPE I (NORMAL)	20 Hz-17 kHz, ±3 dB 20 Hz-18 kHz (DIN)
TYPE II (HIGH)	20 Hz-18 kHz, ±3 dB 20 Hz-19 kHz (DIN)
TYPE IV (METAL)	20 Hz-23 kHz, ±3 dB 20 Hz-24 kHz (DIN)

S/N (Signal level=max recording level, TYPE II type tape)	
NR off	62 dB (A weighted)
Dolby B NR on	71 dB (A weighted)
Dolby C NR on	78 dB (A weighted)
Input sensitivity and impedance	
REC (IN)	100 mV/47 kΩ
Output voltage and impedance	
PLAY (OUT)	500 mV/500 Ω
HEADPHONES	190 mV/(8 Ω) (Load impedance 8 Ω-600 Ω)

## ■ GENERAL

Power consumption	
RS-AZ6	25 W
RS-AZ7	26 W
	2.8 W (Remote control Standby)
	1.6 W (Power Standby)
Power supply	AC 50 Hz, 230-240 V
Dimensions (W×H×D)	430×125×290 mm
Weight	
RS-AZ6	3.9 kg
RS-AZ7	4.2 kg

### Note:

Specifications are subject to change without notice.  
Weight and dimensions are approximate.

# Troubleshooting guide

349

Before requesting service for this unit, check the chart below for a possible cause of the problem you are experiencing. Some simple checks or a minor adjustment on your part may eliminate the problem and restore proper operation. If you are in doubt about some of the check points, or if the remedies indicated in the chart do not solve the problem, refer to the directory of Authorized Service Centers (enclosed with this unit) to locate a convenient service center, or consult your dealer for instructions.

Problem	Probable cause(s)	Suggested remedy
Tape moves but no sound is heard.	The volume control of the amplifier or receiver is set to its minimum position.	• Adjust the volume control to the desired level.
	The input selector of the amplifier or receiver is not set to the "TAPE" position.	• Set to the "TAPE" position.
Distorted sound.	The recording level is too high.	• Select the appropriate recording level.
Previously recorded sound has not been erased.	Erase head is dirty.	• Clean the head.
Sound output is hoarse or unsteady.	Heads are dirty.	• Clean the heads
	Tape is damaged.	• Try operation with a new cassette; if there is no problem with the new cassette, discard the damaged cassette.
Poor sound quality (especially in the high treble and low bass ranges).	The correct Dolby noise-reduction button is not set.	• Set it to the correct position.
Sound is low, poor tone, intermittent sound noise.	Heads, capstan and/or pinch roller are dirty or tape is damaged.	• Clean the heads, capstan and/or pinch roller, or try a new cassette.
A "hum" noise is heard during tape playback or recording.	This unit is placed too close to a receiver, amplifier or tuner.	• Leave as much space as possible between the units, or place them where there is the least amount of "hum".
Recording is not possible.	The recording level control is at the "MIN" position.	• Select the appropriate recording level.
TV noise is accidentally recorded.	This unit is placed near a TV.	• Try placing this unit further away from a TV.

Matsushita Electric Industrial Co., Ltd.  
Central P.O. Box 288, Osaka 530-91, Japan

Printed in Japan

RQT3434-B

H0296J0