

Compact Disc Player

Operating Instructions



Warning

Owner's Record

The model and serial numbers are located at the rear.
Record these numbers in the spaces provided below.
Refer to these numbers whenever you call upon your Sony dealer regarding this product.

Model No. _____ Serial No. _____

To prevent fire or shock hazard, do not expose the unit to rain or moisture.

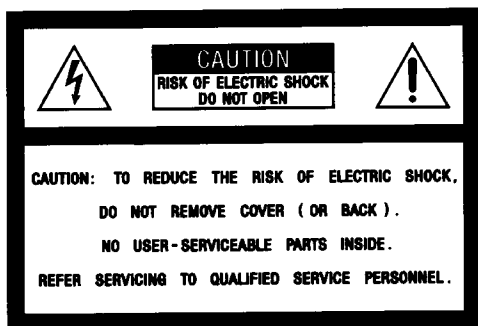

This symbol is intended to alert the user to the presence of uninsulated "dangerous voltage" within the product's enclosure that may be of sufficient magnitude to constitute a risk of electric shock to persons.



This symbol is intended to alert the user to the presence of important operating and maintenance (servicing) instructions in the literature accompanying the appliance.

INFORMATION

This equipment generates and uses radio frequency energy and if not installed and used properly, that is, in strict accordance with the manufacturer's instructions, may cause interference to radio and television reception. It has been type tested and found to comply with the limits for a Class B computing device in accordance with the specifications in Subpart J of Part 15 of FCC Rules, which are designed to provide reasonable protection against such interference in a residential installation. However, there is no guarantee that interference will not occur in a particular installation. If this equipment does cause interference to radio or television reception, which can be determined by turning the equipment off and on, the user is encouraged to try to correct the interference by one or more of the following measures:

- Reorient the receiving antenna
- Relocate the equipment with respect to the receiver
- Move the equipment away from the receiver
- Plug the equipment into a different outlet so that equipment and receiver are on different branch circuits.

If necessary, the user should consult the dealer or an experienced radio/television technician for additional suggestions. The user may find the following booklet prepared by the Federal Communications Commission helpful:

"How to Identify and Resolve Radio-TV Interference Problems". This booklet is available from the U.S. Government Printing Office, Washington, DC 20402, Stock No. 004-000-00345-4.

Enjoy listening in various playing modes

You can select the playing modes among the following:

- Continuous play (page 7) – The entire disc is played once.
- Program play (page 10) – Selections are played in your desired order.
- Shuffle play (page 9) – Selections are played in a random order.
- Repeat play (page 13) – One or all selections are played repeatedly.

Playing the beginning of all selections – Music Scan

You can play the first 12 seconds of all selections continuously to decide which selection to play. (page 14)

Editing your own tapes

- You can fade in and out the play when making your own tape recording. – Fade in/Fade out (page 15)
- **CUSTOM EDIT function**
 - You can confirm the total playing time while choosing the selections to be programmed. – Program edit (page 10)
 - The unit can program selections automatically to fit in a desired duration. – Time edit (page 12)
 - You can stop the play, fading out at the time desired. – Time fade (page 15)
 - You can locate the portion with the largest volume (the peak of the input level) to adjust the recording level. – Peak search (page 15)

Precautions

On safety

- Operate the unit only on 120 V AC, 60 Hz.
- Should any liquid or solid object fall into the cabinet, unplug the unit and have it checked by qualified personnel before operating it any further.
- Unplug the unit from the wall outlet if it will not be used for a long time. To disconnect the cord, pull it out by grasping the plug. Never pull the cord itself.
- As the laser beam used in this compact disc player is harmful to the eyes, do not attempt to disassemble the cabinet. Refer servicing to qualified personnel only.

On operation

When the unit is not used, turn the power off, to conserve energy and to extend the useful life of your unit.

For detailed safety precautions, see the leaflet "IMPORTANT SAFEGUARDS".

If you have any questions or problems concerning your unit, please contact your nearest Sony dealer.

Introducing this CD player	3
Precautions	3
Location of controls	4
Front panel	4
Remote commander	4
Installing the CD player	5
Notes on installation	5
Preparing the remote commander	5
Installing batteries	5
Connecting the CD player	6
Notes on connection	6
Connecting to an amplifier	6
Playing a disc	7
Playing the entire disc	7
Locating a particular selection	8
Locating a particular point in a selection	8
Information display	8
Playing in a random order – Shuffle play	9
Playing in a desired order and time – Program play	10
Designating the playing order – Program edit	10
Programming selections directly	10
Designating the total playing time – Time edit	12
Playing repeatedly – Repeat play	13
Playing the beginning of all selections	
continuously – Music scan	14
Tips on editing tapes	15
Fading in/Fading out	15
Locating the portion with the highest volume	
– Peak search	15
Fading out at the desired time – Time fade	15
Maintenance	16
Cleaning your unit	16
Cleaning discs	16
Specifications	16
Troubleshooting guide	17

Note

In the instruction starting from page 7, buttons on the remote commander are indicated in parentheses, unless mentioned otherwise.



This indicates a function operated only on the main unit.

Location of Controls

Front Panel

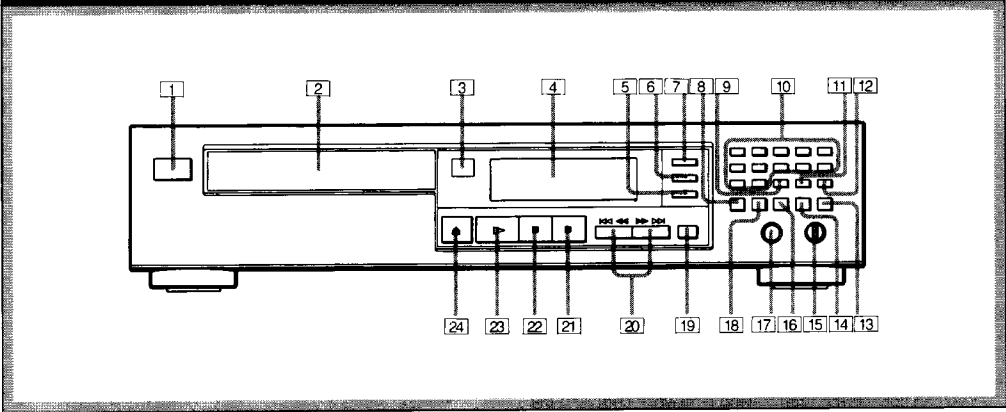

Refer to the pages indicated in ● for details.

- 1 POWER switch ●
- 2 Disc tray ●
- 3 Remote sensor ●
- 4 Display window
- 5 PROGRAM button ●
- 6 SHUFFLE button ●
- 7 CONTINUE button ●, 11
- 8 TIME button ●
- 9 CHECK (program check) button 11
- 10 Numeric buttons ●, 10, ●, 15
- 11 CLEAR (program clear) button ●
- 12 > 12 (over 12) button ●
- 13 MUSIC SCAN button ●
- 14 PEAK SEARCH button ●

- 15 PHONE LEVEL control ●
- 16 FADER button ●, 15
- 17 PHONES jack
- 18 REPEAT button ●
- 19 EDIT/TIME FADE button ●, 15
- 20 ◀◀◀/▶▶▶ (AMS*/RMS**/manual search) buttons ●, 10, ●, 15
- 21 ■ (stop) button ●
- 22 || (pause) button ●
- 23 ▶ (play) button ●
- 24 ▲ OPEN/CLOSE button ●

* AMS is the abbreviation of Automatic Music Sensor.
 ** RMS is the abbreviation of Random Music Sensor.

Remote Commander

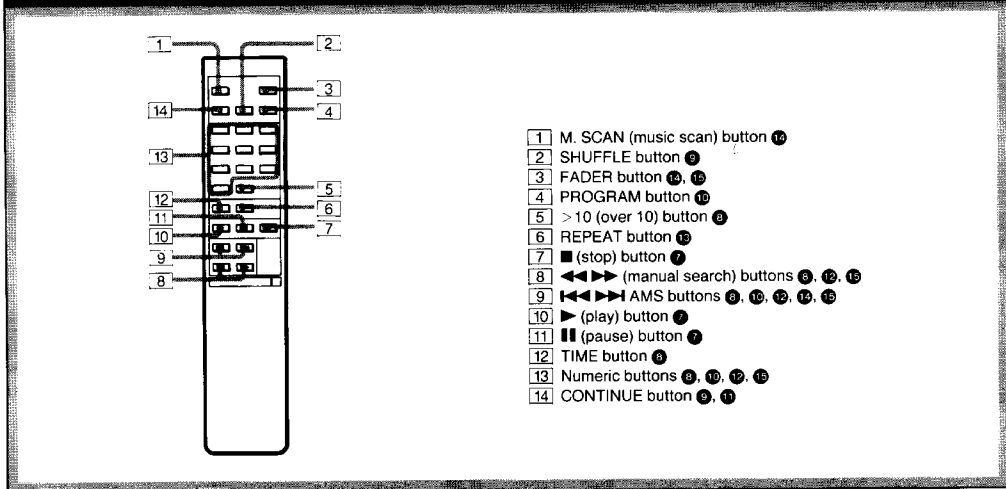

- 1 M. SCAN (music scan) button ●
- 2 SHUFFLE button ●
- 3 FADER button ●, 15
- 4 PROGRAM button ●
- 5 > 10 (over 10) button ●
- 6 REPEAT button ●
- 7 ■ (stop) button ●
- 8 ◀◀▶▶ (manual search) buttons ●, 10, ●
- 9 ◀◀▶▶ AMS buttons ●, 10, ●, 15
- 10 ▶ (play) button ●
- 11 || (pause) button ●
- 12 TIME button ●
- 13 Numeric buttons ●, 10, ●, 15
- 14 CONTINUE button ●, 11

Installing the CD Player

Notes on Installation

- Place the unit in a location with adequate air circulation to prevent internal heat build up in the unit.
- Do not place the unit on a soft surface, such as a rug that would block the ventilation holes on the bottom.
- Do not install the unit:
 - near heat sources such as radiators or air ducts.
 - in a place subject to direct sunlight, excessive dust, mechanical vibration or shock.

Not this way.

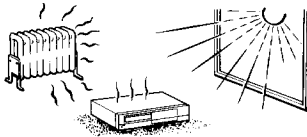

On moisture condensation

If the player is brought directly from a cold to a warm location, or is placed in a very damp room, moisture may condense on the lens inside the unit. Should this occur, the player will not operate. In this case, remove the disc and leave the player turned on for about an hour until the moisture evaporates.

Notes on handling discs

- To keep the disc clean, handle the disc by its edge. Do not touch the surface.



- Do not stick paper or tape on the disc.



- Do not expose the disc to direct sunlight or heat sources such as hot air ducts, nor leave it in a car parked in direct sunlight as there can be a considerable rise in the temperature.
- After playing, store the disc in its case.

Preparing the Remote Commander

Installing Batteries

1

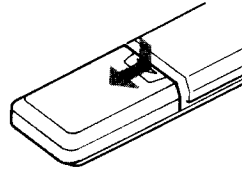

2

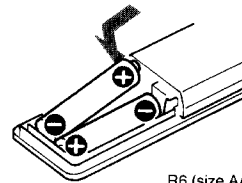

On battery life

- About half a year of normal operation can be expected when using the R6 (size AA) batteries.
- When the batteries are run down, the remote commander will not operate the unit. In this case, replace both batteries with new ones.

Notes on the remote commander and remote control operation

- Keep the commander away from extremely hot or humid places.
- Avoid dropping any foreign objects into the commander casing, particularly when replacing the batteries.
- Avoid exposing the remote sensor to direct sunlight or lighting apparatus. Such exposure can cause a malfunction.
- To avoid damage caused by battery leakage and corrosion, remove the batteries when the commander will not be used for a long time.

Connecting the CD Player

Notes on Connection

- Turn off the power of each unit before making connections.
- Connect the AC power cord last.
- Be sure to insert the plugs firmly into the jacks. Loose connection may cause hum and noise.
- Leave a little slack in the connecting cord to allow for inadvertent shock or vibration.
- Cord plugs and jacks are color coded. Red plugs and jacks are for the right channel (R) and white ones for the left channel (L).

Connecting to an Amplifier

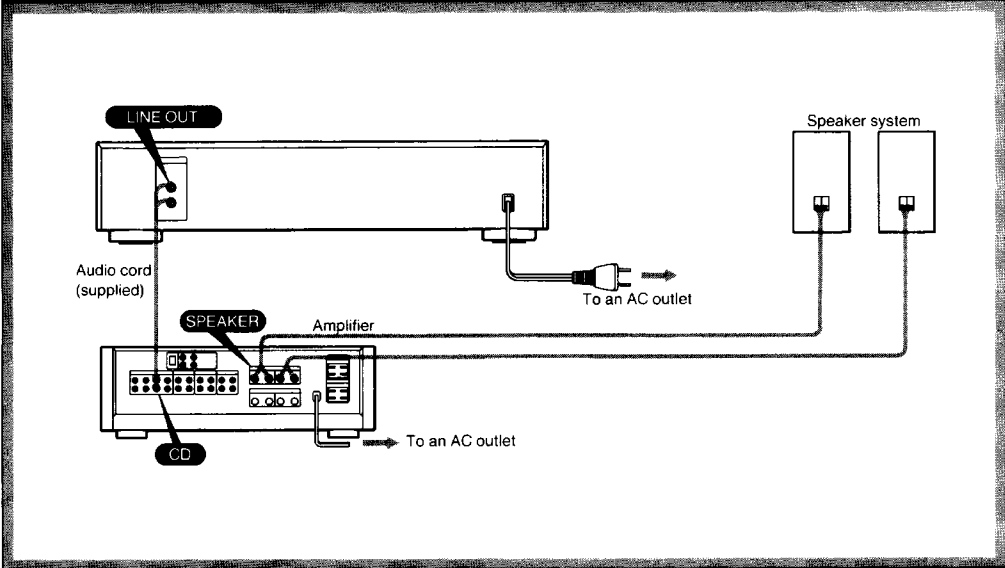

Playing a Disc

Before playing a disc, turn on the amplifier and set the input selector to the CD player position.

Playing the Entire Disc

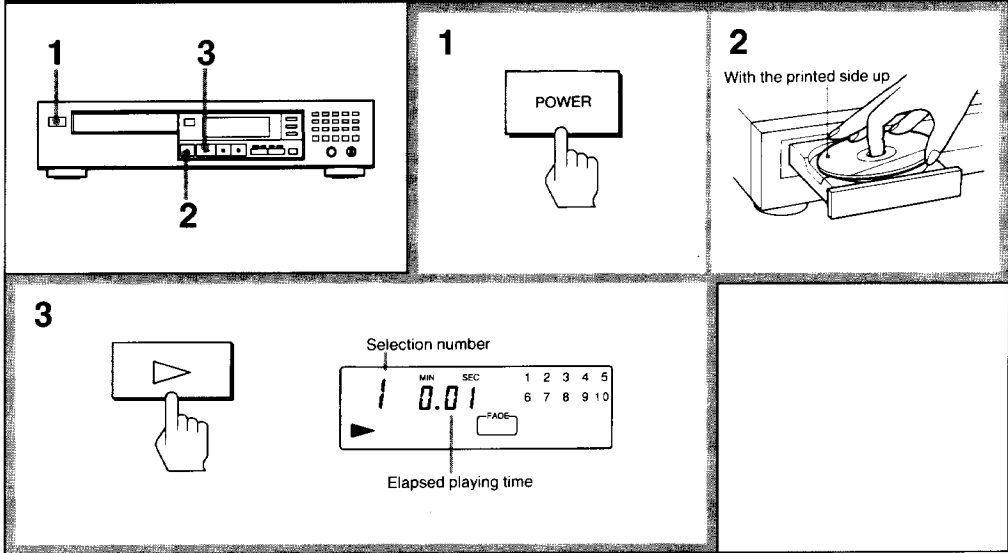

To stop play

To stop for a moment during play, press **II**.

Press **II** or **▶**, to resume play.

To stop play, press **■**.

To stop play and open the tray, press **▲**.

To play a 8cm (3-inch) CD

Place it on the inner circle of the tray. If the disc is provided with an adaptor, first remove it. Do not put a normal CD (12cm/5-inch) on top of an 8 cm CD.

When listening with headphones

Connect the headphones and control the volume with PHONE LEVEL control.

Important

Since the CD system boasts a wide dynamic range, the peaks of high level inputs are recorded with high fidelity, and the noise level is very low.

Do not turn up the volume while listening to a portion with no audio signals or very low level inputs if you do, the speakers may be damaged when a peak level portion is played.

If you turn on the power with a disc in the tray

Play begins automatically from the beginning of the disc. By connecting a commercially available timer, disc play can be started at any desired time.

What is this indication?

no d 15C

This indication appears when there is no disc in the disc tray.

Playing a Disc

Locating a Particular Selection

You can locate the beginning of a desired selection.

To locate sequentially

To locate the beginning of the current or preceding selection

- Press **⏮** (or **⏪**) as many times as required.
- Keep **⏮** (or **⏪**) pressed to skip selections.
(Operable during the stop mode only, when using the button on the main unit.)

To locate the beginning of a succeeding selection

- Press **⏭** (or **⏩**) as many times as required.
- Keep **⏭** (or **⏩**) pressed to skip selections.
(Operable during the stop mode only, when using the button on the main unit.)

To locate directly

Press one of the numeric buttons (**1** to **12** on the main unit, or **1** to **10** on the remote commander) to enter the desired selection number.

If a selection number is greater than 12 (or 10 when using the remote commander), use the **>12** (or **>10**) and **1** to **10** buttons. **10** functions as the figure 0.

e.g. To play from selection No.22

Press **>12** (or **>10**) **2** **2**

To play from selection No.30

Press **>12** (or **>10**) **3** **10**

Locating a Particular Point in a Selection

You can locate a particular point in the disc during play.

To search quickly while monitoring the sound

To go ahead at high speed

Keep **⏭** (or **⏩**) pressed during play and release at the desired point.

To go back at high speed

Keep **⏮** (or **⏪**) pressed during play and release at the desired point.

To search quickly by observing the display

Press **⏏**, then keep **⏮** (or **⏪**) / **⏭** (or **⏩**) pressed. The search speed will increase, but there will be no sound. Find the desired point by observing the display. Press **▶** or **⏏** again at the desired point.

When you press **⏮** (or **⏪**) during play

The unit locates the beginning of the selection.

When **⏏** is displayed

If you continuously press **⏭** (or **⏩**) at the end of the disc, "⏏" appears in the window. Press **⏮** (or **⏪**) to make the display return to normal indication.

If you continuously press **⏮** (or **⏪**) at the beginning of the disc, play begins automatically from the first selection.

Information Display

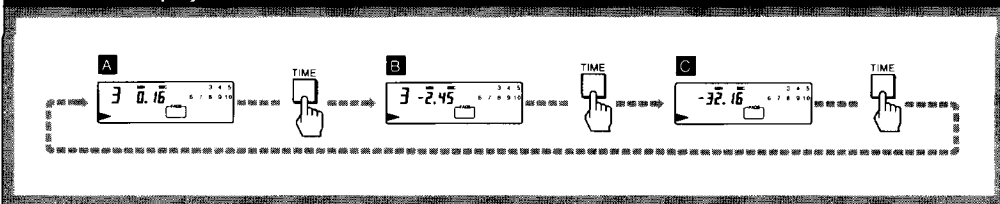

Each time you press **TIME** during play, the display changes to give you the following information.

A Elapsed playing time

B Remaining time in a selection

If the current selection number is over 20, "-- --" is displayed.

C Remaining time of the disc

(not displayed during shuffle play)

If you press **TIME** during stop

The total time and total number of selections will be displayed.

If a program is stored, the total number of programmed selections will be displayed.

Playing in a Random Order

– Shuffle Play

You can have the selections played in a random order. The unit will play all the selections, or just the selections you desire.

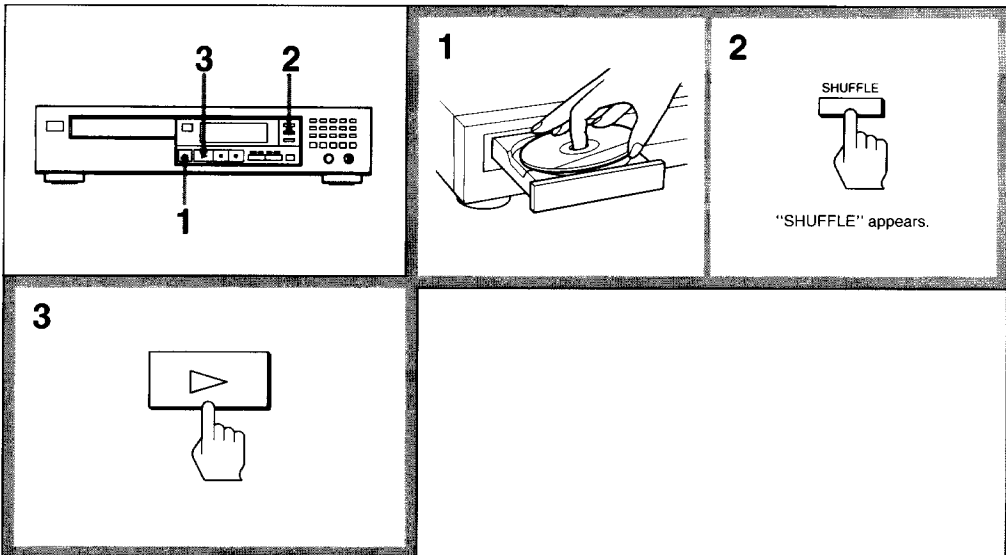

To stop playing

Press ■.

To cancel shuffle play

Press CONTINUE and enter the unit into the normal playing mode. "SHUFFLE" disappears from the window.

To play only the desired selections in a random order – Delete shuffle play

Delete the undesired selections before or during play.

To delete a selection, press the numeric button for that selection. "OFF" will be displayed in the window. You cannot delete a selection which is being played. To choose a selection number over 12 (or 10 when using the remote commander), see page 8.

To put back a selection which you have deleted, press the numeric button for that selection. "On" will be displayed in the window.

To put back all the selections you have deleted, press ■ during the stop mode.

When delete shuffle play ends

The unit will be ready to play the same remaining selections in a different order.

If you press SHUFFLE during play

Shuffle play begins after the current selection is over.

What is this indication?



This indication appears while the unit is "shuffling" the selections.

Playing in a Desired Order and Time

- Program Play

You can make a program, which can be divided into programs A and B designating up to 24 selections in the order you want them to be played. At the same time, you can adjust the total playing time of the program. The unit will play the disc according to your program. This function is convenient for editing tapes.

Designating the Playing Order - Program Edit

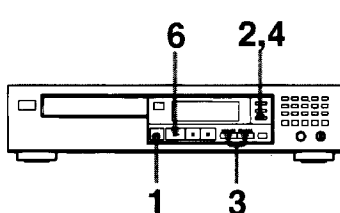

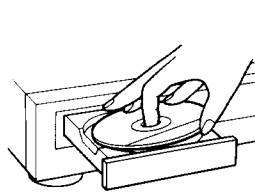
1 

2 

3 Choose a selection and check the time.
If the time is not satisfactory, choose another selection.

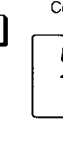

Current selection
5
MIN SEC 2
12.38
PROGRAM FADE 8

Total time

4 Store the selection.

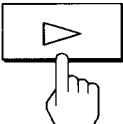

5 Repeat steps 3 and 4.

6 Play the program

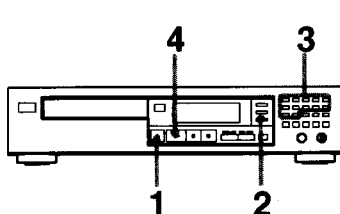
Programming Selections Directly

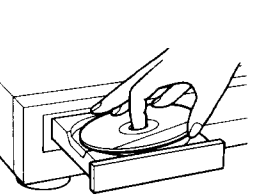

1 

2 

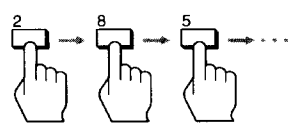
3 Press selection numbers in desired order.*

Current selection Chosen selections
5 MIN SEC 2
12.38
PROGRAM FADE 8

Total time

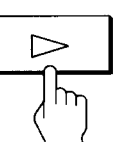
4 Play the program

* To choose a selection number over 12 (or 10 when using the remote commander), see page 8.

To stop playing

Press ■.

You can play the same program repeatedly as long as you do not cancel program play or erase the program.

To cancel the program play

Press CONTINUE and enter the unit into the normal playing mode.

The program will be erased.

To erase the entire program

Press ■ once during stop; twice during play.

The program is also erased when you press  or turn off the unit.

To make a program for editing a tape

You can divide your program into programs A and B by inserting a pause between them. Use this function to make a program for both sides of the tape at one time.

- 1 Program the selections for program A.
- 2 Press ■■. "B" in the tape indicator and "P" will be displayed in the window and the total playing time will be reset to 0.

3 Program the selections for program B.
When you start playing the selections, program A will be played and then the unit will pause with the chosen selections for program B lighted in the window. Set the tape to the beginning of side B, then press  or ■■. The selections for program B will be played.

What is the tape indicator ?

During program play, the tape indicator shows you which side of the tape is being played.



: Side A is being played.



: Side A has been played and the unit is in the pause mode, or side B is being played.

To check your program



Press CHECK. The first selection in the program will be displayed. When CHECK is pressed during play, the selection being played is displayed.

Each time you press CHECK, the next selection in the program will be displayed. The tape indicator, at this time, will show you which side of the tape these selections have been programmed into.

After the last selection, "End" will be indicated and the display will soon return to the initial status in one second.

To change your program

You can make the following changes before starting play.

To erase the last selection, press CLEAR.



Each time you press CLEAR, the last selection in the program will be erased.

To add a selection to the end of the program, just

press the numeric button for that selection. You can add a selection also during play or pause.

To delete a selection, press CHECK repeatedly until



the undesired selection is displayed. Then press CLEAR.

To change the order, press ■ during stop to erase the

program. Then repeat the programming procedure from the beginning.

If "-- --" is displayed instead of the actual time

- you have programmed a selection number over 20.
- the total time is more than 100 minutes.

To check the number of programmed selections

Press TIME during the stop mode. The number of programmed selections will be displayed in the window.

To check the remaining time

Press TIME once to see the remaining time of the selection being played; twice to see the total remaining time; once more to return to the initial display.

If you have divided the program into A and B by inserting a pause between them, the display shows the remaining time until the pause. If you have programmed a selection number over 20, "-- --" is displayed instead of the actual time.

Designating the Total Playing Time

- Time Edit



You can designate a time and the unit will make 2 different programs of selections each fitting within that period. Use this function, by designating the length of your tape, for editing both sides of a tape.

- * To adjust the second
- Pressing numeric buttons (1 to 10) for seconds allows you to designate the time precisely. (Press 10 for "0".)
 - Keeping **◀◀◀/▶▶▶** (or **◀/▶**) on the remote commander pressed changes the set time by 10 second intervals.

To play the program

Press **▶**.
The selections for side A will be played and then the unit will pause. Set the tape to the beginning of side B, then press **▶** or **■**. The selections for side B will be played.

To check or erase the program and to stop or cancel the play

See the preceding page.

** You need not press buttons for seconds, unless required.

To include desired selections in the program

- 1 Make your own program of the desired selections. See page 10 for instructions.
- 2 Follow the above procedure. Just designate the length of your tape; you need not subtract the length of your program. The unit will place your selections at the beginning of its program and add other selections to fit the remaining time.

If your tape is of a standard length

You can designate the tape length easily with **◀◀◀/▶▶▶** (or **◀/▶**) buttons.

Press **◀◀◀/▶▶▶** (or **◀/▶**) at step 3 above. Each time you press **◀◀◀/▶▶▶** (or **◀/▶**), the display changes to give you the following duration:

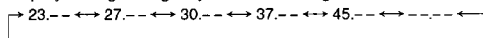

If your disc has more than 20 selections

Selections over number 20 cannot be programmed with the time edit function; use the programming procedure on page 10.

Playing Repeatedly

- Repeat Play

You can repeat one or all selections during play.

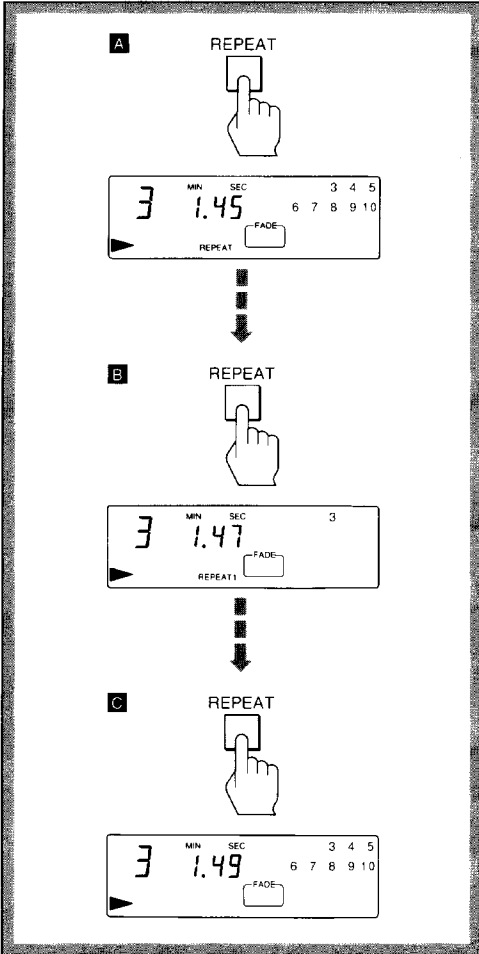

A To repeat all selections

Press REPEAT once. "REPEAT" appears.
(The unit will repeat the selections in the current play mode after completing the first play.)

Play mode	Selections to be repeated
Continuous play (page 7)	All the selections
Program play (page 10)	All the programmed selections in the same order
Shuffle play (page 9)	All the selections that the unit reshuffles
Delete shuffle play (page 9)	All the remaining selections that the unit reshuffles

B To repeat the selection being played (only during the continuous play)

Press REPEAT again. "REPEAT 1" appears.
(Not operable during shuffle, delete shuffle, or program play.)

C To cancel repeat play

Press REPEAT again. "REPEAT 1" disappears.

If you press REPEAT during delete shuffle play

Shuffle play of the remaining selections will be repeated in a different order after completing the first play.

Playing the Beginning of All Selections Continuously

– Music Scan

You can play the first 12 seconds of all selections continuously with the MUSIC SCAN (or M.SCAN) button. This is convenient for deciding which selection to play, or to check the order of selections for program play.

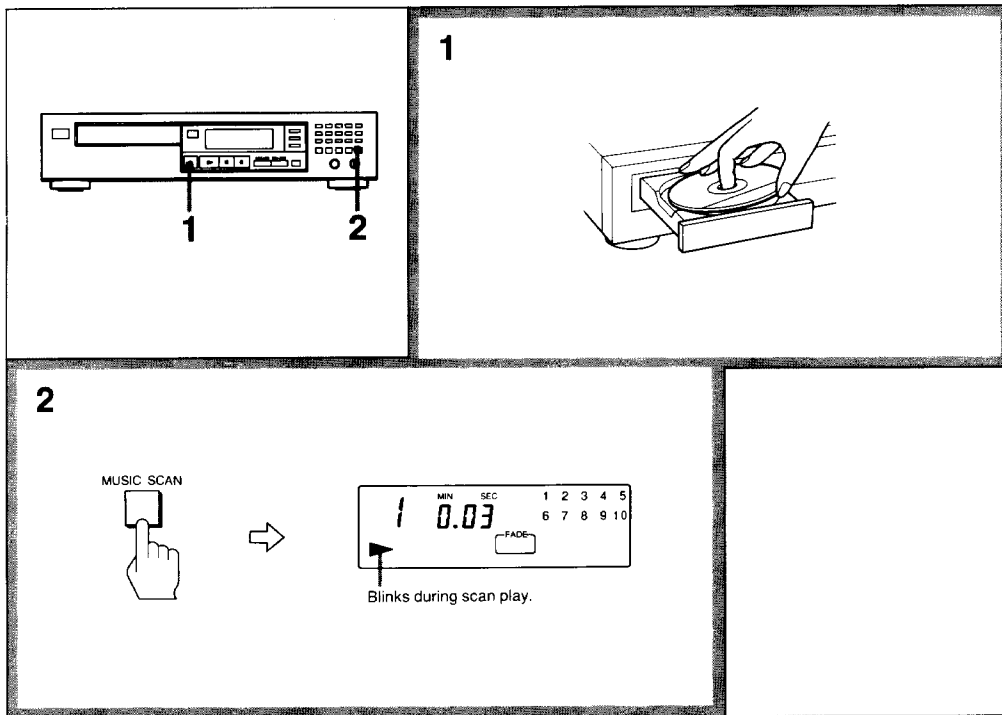

Each selection will be played for 10 seconds and then fades out for 2 seconds. After all selections are played, scan play will end.

To play any given selection

Press ► while it is being played for 10 seconds. ► stops blinking and the play of the selection will be continued. If you press ► while it is fading out, the unit will enter the pause mode.

To skip to other selections

Press ◀◀◀/▶▶▶ (or ◀◀/▶▶).

If you press MUSIC SCAN (or M.SCAN) during scan play

Play of the current selection will be extended for another 12 seconds from that point.

If a program is stored

The selections will be scan played in the programmed order.

If you press FADER during scan play

The selection will fade out if it is pressed for the first 10 seconds, or fade in if it is pressed while fading out for the last 2 seconds.

Tips on Editing Tapes

The following functions are convenient for editing your own tapes.

Fading in/Fading out

You can have the play fade in or fade out from 2 to 10 seconds.

To designate the fading duration

- 1 Press FADER during the stop mode.
- 2 Designate the fading duration within the range of 2 to 10 seconds by pressing **◀◀◀/▶▶▶** (or **◀◀/▶▶**, **◀/▶**).

No designation makes the fading duration 5 seconds long.

To end the play fading out

Press FADER when you want to start fading out. "■" flashes in the window, and play fades out for the designated duration and enters the pause mode.

To restart the play fading in

Press FADER.
"◀■" flashes in the window, and play fades in for the designated duration.

Locating the Portion with the Highest Volume – Peak Search

You can locate the portion with the highest input level to adjust the recording level.

Before starting play, press PEAK SEARCH.
"PEAK" appears in the window and starts blinking as the peak search begins functioning. It takes time for the unit to carry out the peak search. On completing the search, the unit starts repeating the portion with the peak volume.

While the unit is repeating the peak portion

- Press **||** to enter the unit into the pause mode at the beginning of the first selection.
- Press **▶** to start play from the first selection.

To cancel the peak search

Press **■**. "PEAK" disappears from the window.

Note

During program mode, the peak search will not function if nothing is programmed.

On peak search

The unit scans input levels of the whole CD and determines the peak (maximum input level) among them. The peak determined with this function is sometimes slightly different from the real one. In addition, portions determined as a peak may vary each time this function is carried out even on the same CD. The difference between the determined and the real peak is, however, negligible enough for you to adjust the recording level.

If you press PEAK SEARCH before delete shuffle or program play
The unit scans the input levels of the chosen selections only.

Fading Out at the Desired Time – Time Fade



You can have the play fade out at the end by designating the play duration. Once the time fade is set, it functions twice for editing both sides of a tape. You can change discs without cancelling this function and enjoy it in any play mode.

- 1 Press EDIT/TIME FADE twice during the stop mode. "TIME FADE" is displayed in the window.
- 2 Set the desired play duration, using **◀◀◀/▶▶▶** (or **◀◀/▶▶**) or numeric buttons.

◀◀◀/▶▶▶ (or **◀◀/▶▶**) – Useful when using commercial tapes (46-, 54-, 60-, 74- and 90-minute tapes).

Each time you press **◀◀◀/▶▶▶** (or **◀◀/▶▶**), the play duration for one side of the tape is displayed as follows.

→ 23.-- ↔ 27.-- ↔ 30.-- ↔ 37.-- ↔ 45.-- ↔

To adjust the second

- Keeping **◀◀◀/▶▶▶** (or **◀◀/▶▶**) on the remote commander pressed changes the set time by 10 second intervals.
- Pressing numeric buttons (**[1]** to **[10]**) for seconds allows you to designate the time precisely. (Press **[10]** for "0".)

- 3 To start play, press **▶**.
Before the unit enters the pause mode at the set time (the tape indicator changes to B), play starts to fade out from 2 to 10 seconds according to the fading duration you have designated.

To start play for the other side of the tape

Press **||**, **▶** or FADER. (Pressing FADER starts the play fading in.)
When this play ends, time fade is cancelled.

If you want to start the play fading in

- 1 Press **||**.
The unit enters the pause mode.
- 2 Press EDIT/TIME FADE once.
"TIME FADE" is displayed.
- 3 Set the desired play duration, following the step 2 above.
- 4 To start play, press FADER.
Play will start fading in and end at the set time fading out.

To cancel time fade

– Press EDIT/TIME FADE again.
– Press PEAK SEARCH during the stop mode.
Time fade is also cancelled when **◀◀◀/▶▶▶** (or **◀◀/▶▶**) or FADER is pressed during play.

To display the remaining time until the set time

Press TIME twice. In the shuffle play mode, however, the remaining time until the fade-out time is not displayed.

Maintenance

Cleaning Your Unit

Clean the cabinet, panel and controls with a soft cloth lightly moistened with a mild detergent solution. Do not use any type of abrasive pad, scouring powder or solvent such as alcohol or benzene.

Cleaning Discs

When a disc becomes dirty, clean it with a cleaning cloth. Wipe the disc from the center out.

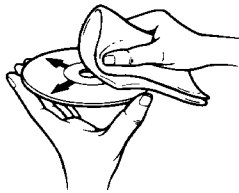

Do not use solvents such as benzene, thinner, commercially available cleaners or anti-static spray intended for analog discs.

Specifications

Compact disc player

Frequency response	2Hz – 20 kHz \pm 0.5 dB
Signal to noise ratio	More than 100 dB
Dynamic range	More than 97 dB
Harmonic distortion	Less than 0.005%
Channel separation	More than 95 dB

Outputs

LINE OUT (phono jacks)	Output level 2 V (at 50 kilohms) Load impedance over 10 kilohms
PHONES (stereo phone jack)	Output level max. 10 mW Load impedance 32 ohms

General

Power requirements	120 V AC, 60 Hz
Power consumption	12 W
Dimensions (approx., including projections)	430 \times 100 \times 280 mm (w/h/d) (17 \times 4 \times 11 $\frac{1}{8}$ inches)
Weight (approx.)	3.5 kg (7 lbs 12 oz)

Supplied accessories

Audio cord	1 (2 phono plugs – 2 phono plugs)
Remote commander	1
R6 (size AA) batteries	2

Remote commander RM-D295

Remote control system	Infrared control
Power requirements	3 V DC with two R6 (size AA) batteries
Dimensions	Approx. 40 \times 20 \times 175 mm (w/h/d) (1 $\frac{1}{8}$ \times $\frac{13}{16}$ \times 7 inches)
Weight	Approx. 95 g (4 oz) Including batteries

Design and specifications subject to change without notice.

Troubleshooting Guide

Before going through the check list below, first refer back to the connections and operating procedures.

Should any problem persist after you have made these checks, consult your nearest Sony service facility.

Symptom	Cause	Remedy
The disc tray does not close.	The disc is not placed correctly.	Place the disc correctly on the disc tray.
Play does not start.	Dirty disc.	Clean the disc.
	The disc is inserted upside down.	Insert the disc with the printed side up.
	⏸ is engaged and the unit is in the pause mode.	Press ▶ or ⏸ again to release it.
	Moisture condensation.	Leave the unit turned on for approximately one hour.
"no disc" displayed.	There is no disc in the unit.	Insert a disc.
Sound is not heard.	Loose connection.	Insert the plug firmly.
	Connection is incorrect.	Check the connection referring to "Connecting the CD Player".
	The PHONE LEVEL control is set to the minimum.	Turn the control clockwise.
⏮ is displayed when you keep ▶▶▶▶ (or ▶▶) pressed.	▶▶▶▶ (or ▶▶) was continuously pressed at the end of the disc.	Press ◀◀◀◀ (or ◀◀, ◀◀◀) to return to normal indication.
Play does not begin from the first selection.	The unit is in the program or the shuffle mode.	Press CONTINUE.
Play begins only by turning on the power.	A disc is in the tray.	—
The remote commander does not operate the unit.	The batteries are run down.	Replace both batteries.
	The remote commander is not pointed at the remote sensor.	Point the remote commander at the sensor.
	There is an obstacle between the remote commander and the unit.	Remove the obstacle.
	The remote commander is too far from the unit.	Move closer.
No operation is possible.	The internal control program may not run.	Turn off the power and turn it on again.